

ReidBraceTM

Design Guide



This Document contains important user information with regards to the ReidBraceTM Engineered Bracing System

For more information on our products call **0800 72 67 38**
Or go on our website
ramset.co.nz



ReidBrace™

Engineered Bracing System

ReidBrace™ is an off the shelf, out of the box system that provides design engineers and installers with an economic solution for tension bracing of structures, tie-back applications, retrofits and temporary works bracing with proven performance.

ReidBrace™ utilises ReidBar™, a user friendly continuously threaded 500E grade reinforcing bar as the tension member. ReidBrace™ is a unique system that is as easy as screwing on a thread to install, minimising fabrication time.

Seismic Performance

ReidBrace™ has been tested and validated for Seismic Performance through an extensive test program at the University of Auckland's Structural Test Laboratory & Holmes Solutions Test Laboratory.

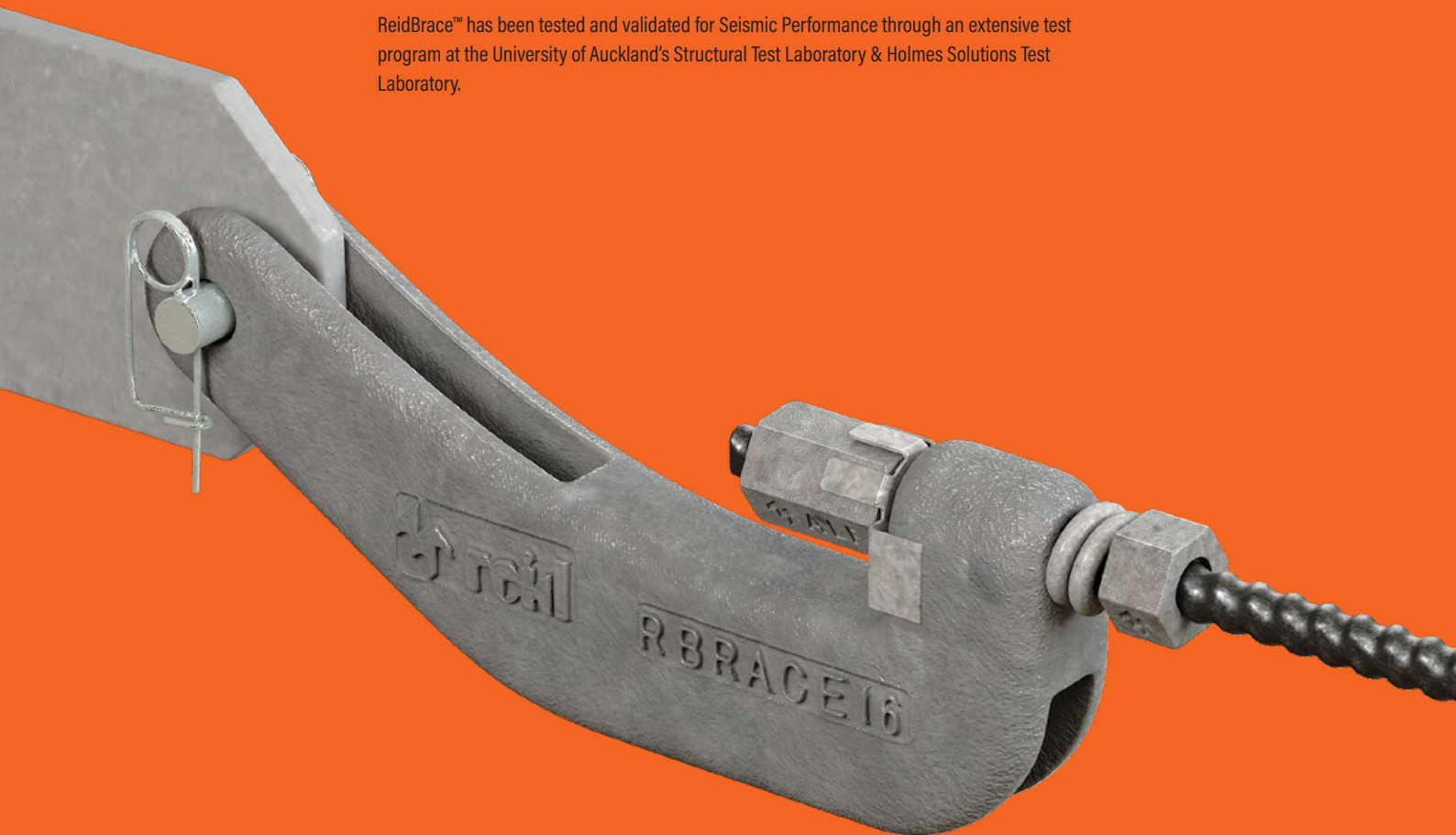

ReidBrace™

Boxed Set Contents

ReidBrace™ Boxed Set Contents

1. Reid™ Tension Spring
2. Reid™ Tab Washer
3. RBRACE
4. RBRACE-END
5. Full nut & Half nut*
*full nut may be supplied in lieu of half nut, depending on product availability.
6. Pin and Clip

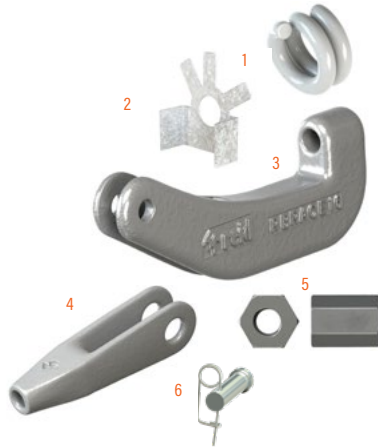

ReidBrace™ Boxed Set Kit Codes

Bar Size	Finish*	Kit Code
12mm	Galvanised	RBRACE12-SET
16mm	Galvanised	RBRACE16-SET
20mm	Galvanised	RBRACE20-SET
25mm	Galvanised	RBRACE25-SET
32mm	Galvanised	RBRACE32-V2SET

Typical Applications



Temporary Work / Platform Bracing

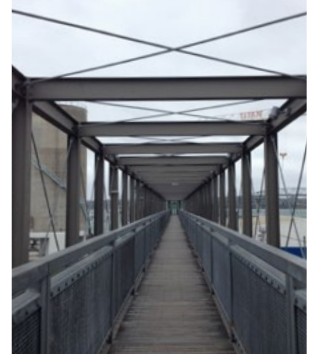

Architectural Structure Bracing



Structural Steel Structure Bracing



Timber Structure Bracing

ReidBrace™

✔ Benefits, Advantages and Features

Ease of Installation

ReidBrace™ is supplied in boxed sets, simple to install complete with a step by step installation procedure.

Performance Tested

ReidBrace™ has been performance tested as a system at the University of Auckland's Structural Test Laboratory & Holmes Solutions Testing Laboratory.

Simple to Design

No welding nor custom design of bracing element. Furthermore, Ramset™ provides recommendations on steel cleat connection design.

Trusted ReidBar™ Tension Rod

ReidBrace™ utilises the 500E ReidBar™ reinforcing rod. Widely recognised and readily available in the market, ReidBar™ is locally manufactured by ACRS certified Pacific Steel to AS/NZS 4671.

Quality Assured Products

ReidBrace™'s banana fittings, end fittings and nuts are manufactured to ASTM A536 Grade 100-70-03 / ISO 1083 Grade 600-3 SG Iron by ISO 9001 accredited manufacturer.

ReidBrace™ load bearing components are batch tensile tested to destruction at Ramset™ facility.



Design Data

Structural Displacement Ductility Factor (μ)

Structural Category (NZS 3404 12.2.3) and maximum Structural Displacement Ductility Factor for design:

Diameter	S. Cat. 4 max μ_{des}	S. Cat. 3 max μ_{des}	S. Cat. 2 max μ_{des}^*	S. Cat. 1 max μ_{des}^*
12mm	1	1.25	3	5
16mm	1	1.25	3	5
20mm	1	1.25	3	5
25mm	1	1.25	---	---
32mm	1	1.25	---	---

*Please consider the behaviour of the overall structure when using higher ductility values.

Tensile Capacities - kN (ReidBrace™ System)

ϕN_u = Reduced Characteristic Capacity (UTS Tested) where $\phi = 0.9$

ϕN_t = Limit State Design of System (Yield Theory) where $\phi = 0.9$

Diameter	Tested Capacity* (ϕN_u) per brace	Design Capacity** (ϕN_t) per brace
12mm	63kN	51kN
16mm	112kN	91kN
20mm	180kN	141kN
25mm	255kN	221kN
32mm	479kN	362kN

*Note: Tested Capacity demonstrates suitability of Recommended Design Capacity as per procedure of NZS 3404 C17.5 & AS/NZS 1170.0 Appendix B.

**Note: The Recommended Design Capacity is based on nominal yield strength of Grade 500E ReidBar™ used as part of the ReidBrace™ System.

Overstrength Factor

Overstrength loads have been determined following the principles of NZS 3404, based on the experimental testing undertaken. The overstrength is to be resisted by the design capacity of secondary elements of the steel system, in a capacity designed system.

	S. Cat. 4 max μ_{des}	S. Cat. 3 max μ_{des}	S. Cat. 2 max μ_{des}	S. Cat. 1 max μ_{des}
Overstrength factor (ϕ_{oms})	1	1.25	1.30	1.35

Equivalent Elastic Modulus

New method of determining Equivalent Elastic Modulus as per Holmes testing summary Table 5

Component	Elastic modulus (MPa) for braces > 4.0m	Elastic modulus (MPa) equation for braces <4m (L_{total} in mm)
ReidBrace 12	160,000	$E_{eq} = \frac{(200,000 \times L_{total})}{(1340 + L_{total})}$
ReidBrace 16	145,000	$E_{eq} = \frac{(200,000 \times L_{total})}{(2170 + L_{total})}$
ReidBrace 20	140,000	$E_{eq} = \frac{(200,000 \times L_{total})}{(2715 + L_{total})}$
ReidBrace 25	135,000	$E_{eq} = \frac{(200,000 \times L_{total})}{(2950 + L_{total})}$
ReidBrace 32 V2	155,000	$E_{eq} = \frac{(200,000 \times L_{total})}{(1875 + L_{total})}$

Preloading Bracing System

Tension on structural bracing span should meet L/100 sag criteria.

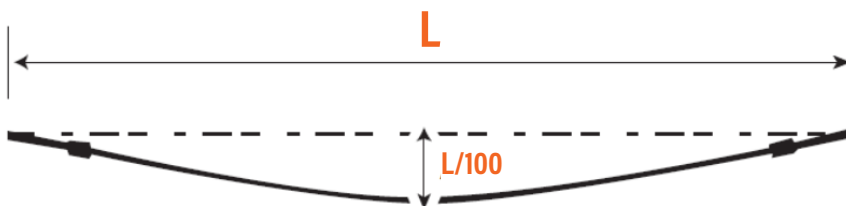

Ref:

HERA report R4-80 section 3.3.2
 Woolcock, S T and Kitipornchai, S; Tension Members and Self-Weight; Steel Construction, Vol. 19, No. 1, May 1985, Australian Institute of Steel Construction.

Ply in Bearing Design Recommendations

The following are ply in bearing design capacities derived in conjunction with Associate Professor Charles Clifton based upon the University of Auckland testing programme. Numerous plate thicknesses and steel grades were considered to provide Design Engineers with options.

Refer to Charles Clifton letter summarising the testing performed at the University of Auckland and letter summarising the testing performed at Holmes Solutions.

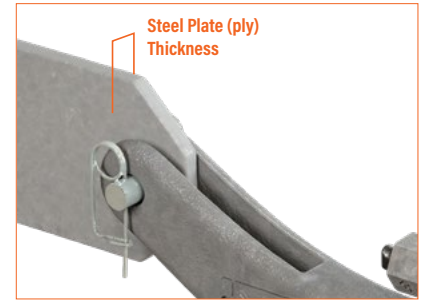

The following tables are based on ϕV_b Ply in Bearing equal to or greater than N_{ov} for the respective structural categories.

Nominal Load (ReidBrace™) - kN

Diameter	Nominal Load (N_{nom}) per brace
12mm	57 kN
16mm	101 kN
20mm	157 kN
25mm	246 kN
32mm	402 kN

Legend:

- N_{nom} = ReidBrace™ Nominal Load where $N_{nom} = f_y * A_b$
 - ϕ_{oms} = Overstrength Factor
 - N_{ov} = ReidBrace™ Overstrength Loads = $N_{nom} \phi_{oms}$
 - f_y = Yield stress
 - A_b = Stress area of bar
- = Suitable for structural category 4 ($\mu = 1.0$)
 - = Suitable for structural category 3 & 4 ($\mu \leq 1.25$)
 - = Suitable for structures of every category

12mm ReidBrace™ ϕV_b Ply in Bearing (kN)			
Steel Grade	Thickness of cleat plate (mm)		
	10	12	14
G 250	115	138	161
G 300	120	144	169
G 350	126	151	176

16mm ReidBrace™ ϕV_b Ply in Bearing (kN)				
Steel Grade	Thickness of cleat plate (mm)			
	10	12	14	15**
G 250	115	138	161	172
G 300	120	144	169	181
G 350	126	151	176	189

**non standard plate thicknesses will require welding additional steel plate to increase overall cleat thickness
For hole to cleat edge distances, please refer NZS3404 clauses 9.6.2 & 12.9.4.4

20mm ReidBrace™ ϕV_b Ply in Bearing (kN)			
Steel Grade	Thickness of cleat plate (mm)		
	16	18	20
G 250	230	259	287
G 300	241	271	301
G 350	252	284	315

25mm ReidBrace™ ϕV_b Ply in Bearing (kN)			
Steel Grade	Thickness of cleat plate (mm)		
	20	22	25
G 250	431	474	539
G 300	452	498	566
G 350	473	521	592

32mm ReidBrace™ ϕV_b Ply in Bearing (kN)			
Steel Grade	Thickness of steel plate (mm)		
	28	30	32
G 250	556	596	636
G 300	649	695	741
G 350	708	758	809

Technical Data

Product Specification - Dimensions of RBRACE (mm)

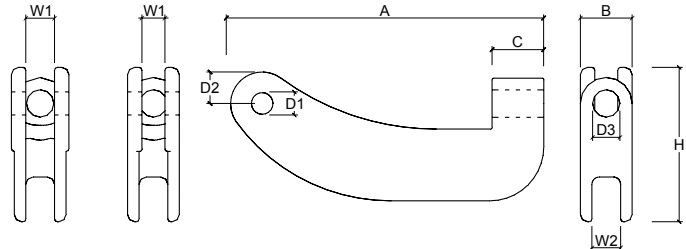

RBRACE									
Size	A	B	C	D1	D2	D3	H	W1	W2
12/16	276	36	46	17	25	19	107	16	20
20	345	45	58	21	32	24	134	21	25
25	382	53	73	31	40	29	149	26	29
32	434	68	72	31	44	38	170	34	34

Product Specification - Dimensions of RBRACE-END (mm)

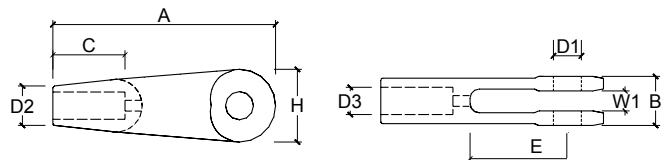

RBRACE-END									
Size	A	B	C	D1	Pin	E	H	W1	D3
12	145	32	50	17	16	50	40	16	Bar Diameter
16	160	36	55	17	16	67	50	16	-
20	195	45	60	21	20	88	60	21	-
25	247	50	80	31	30	108	80	26	-
32	282	70	104	31	30	114	88	34	-

Additional notes:

- Testing follows the principles of AS/NZS 1170.0
- For detailing of the hole in the cleat, position & tolerance, refer to NZS 3404
- Service temperature of the ReidBrace™ system (from NZS 3404 & AS 4100), should be limited to -5°C using the above information
- 3x 32mm HDG ReidBrace™ pin samples have been Charpy impact tested at 0°C with an average result of 140J.
- This document supersedes any previous publication

ReidBrace™

Design Data

Minimum Angle of Bracing to Fixture

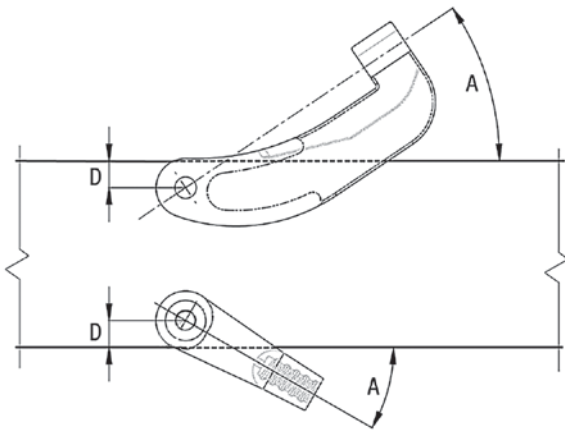

Bar Size (mm)	Edge Distance D (mm)	Min angle A°	Brace	End
12	32	48	RBRACE12/16	RBRACE12-END
16	32	48	RBRACE12/16	RBRACE16-END
20	40	36	RBRACE20	RBRACE20-END
25	60	46	RBRACE25	RBRACE25-END
32	60	44	RBRACE32 V2	RBRACE32-V2 END

Bar Length for Bracing Application

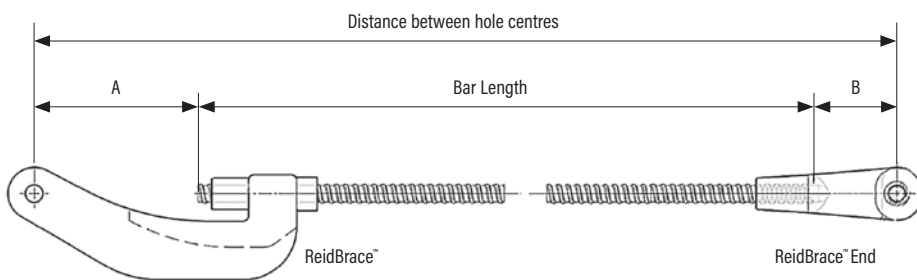

ReidBar™ Size	Brace	A+/-5mm	ReidBrace™ End	B+/-5mm	A+B mm
RB12	RBRACE12/16	135	RBRACE12-END	75	210
RBA16	RBRACE12/16	130	RBRACE16-END	80	210
RB20	RBRACE20	170	RBRACE20-END	105	280
RB25	RBRACE25	175	RBRACE25-END	125	300
RB32	RBRACE32 V2	200	RBRACE32-V2 END	135	335

ReidBrace™

Material Data

ReidBrace™ Pin sizes (mm)

RBRACE Set	Pin Size (Diameter x Length, mm)
RBRACE12-SET & RBRACE16-SET	16 x 50
RBRACE20-SET	20 x 59
RBRACE25-SET	30 x 68
RBRACE32-V2 SET	30 x 83



For applications requiring coupling system

When ReidBar™ bracing lengths need to be coupled, Reid Steel couplers need to be used. When using ReidBar™ Couplers for this application, Epon™ C8 will be required only to install the coupler – not the ReidBrace™ End and the ReidBar™ Nut.

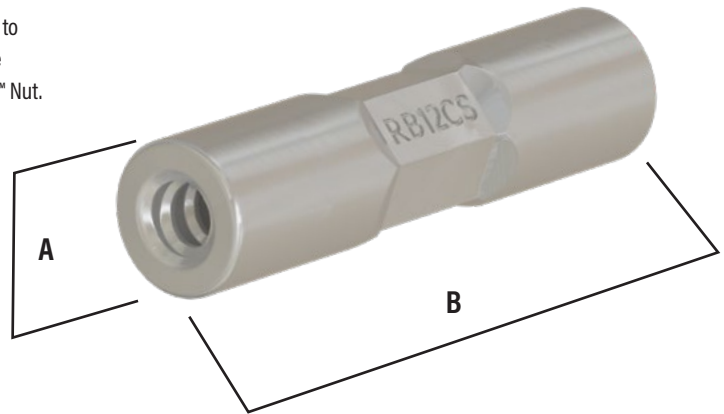

Part No.	Description	Hex A/F (mm)	Length (B) (mm)	Body Diameter (A) (mm)	Min Threaded Depth (mm)
RB12CS	12mm Steel ReidBar™ Coupler	26	130	32	50
RBA16CS	16mm Steel ReidBar™ Coupler	26	136	32	54
RB20CS	20mm Steel ReidBar™ Coupler	32	148	35	60
RB25CS	25mm Steel ReidBar™ Coupler	38	193	42	80
RB32CS	32mm Steel ReidBar™ Coupler	52	242	60	102
RB12CSG	12mm Steel ReidBar™ Coupler (HDG)	26	130	32	50
RBA16CSG	16mm Steel ReidBar™ Coupler (HDG)	26	136	32	54
RB20CSG	20mm Steel ReidBar™ Coupler (HDG)	32	148	35	60
RB25CSG	25mm Steel ReidBar™ Coupler (HDG)	38	193	42	80
RB32CSG	32mm Steel ReidBar™ Coupler (HDG)	52	242	60	102

ReidBrace™

Installation Guidelines



Step 1: Checks

1. Check if all RBRACE components are in the box.
2. Check if the RBRACE fitting flanges will fit onto the steel cleat.

Boxed Set Contents:

1. Reid™ Tension Spring
2. Reid™ Tab Washer
3. RBRACE
4. RBRACE-END
5. Pin and Clip
6. Full nut & Half nut*
*full nut may be supplied in lieu of half nut, depending on product availability.

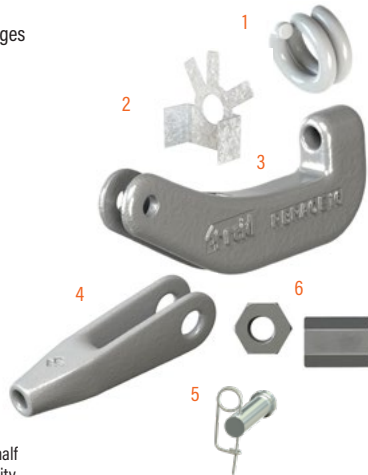

Step 2: Measure

1. Measure the centre to centre distance between the holes on the steel cleat.
2. Subtract the above length by A+B as per the following table. This is the length of ReidBar™ to be cut.

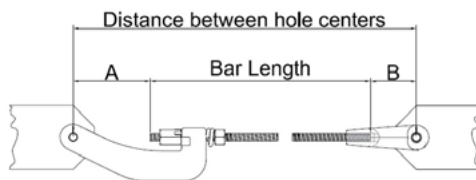

ReidBar™ Size	RBRACE	A ± 5mm	RBRACE__-END	B ± 5mm	A + B (mm)
RB12	RBRACE12/16	135	RBRACE12-END	75	210
RBA16	RBRACE12/16	130	RBRACE16-END	80	210
RB20	RBRACE20	170	RBRACE20-END	105	275
RB25	RBRACE25	175	RBRACE25-END	125	300
RB32	RBRACE32 V2	200	RBRACE32-V2-END	135	335

Step 3: Assemble



1. Insert ReidBar™ into the RBRACE-END fitting and tighten.
2. Insert ReidBar™ Half Nut into the other side of the bar, followed by inserting the tension spring.
3. Slide the RBRACE Fitting onto the ReidBar™, followed by inserting the tab washer onto the ReidBar™ with the tabs facing the nut.

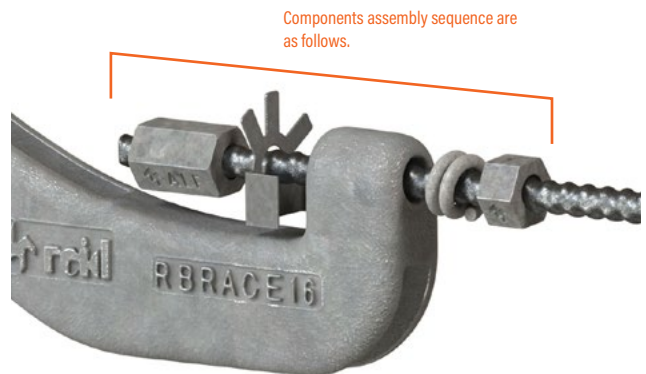

4. Wind ReidBar™ Nut onto the ReidBar™ until it is flush with the end of the ReidBar™. This will give adjustability to the RBRACE fitting upon installation.

ReidBrace™

Installation Guidelines

Step 4: When coupling is required

1. Acquire ReidBar™ Steel Coupler & EPCON™ C8 Epoxy for the corresponding bar size.
2. Inject the required amount of pumps of EPCON™ C8 into one side of the Steel Coupler. Start from the bottom of the thread and draw the nozzle out from the component in a rotating motion as the epoxy is being injected.



3. Screw the Steel Coupler onto the first ReidBar™, and tighten coupler using a wrench to ensure that the ReidBar™ is hard against the stop. Wipe excess filler with cloth/fabric/carton as applicable.



4. Inject the recommended number of pumps of EPCON™ C8 into one side of the Steel Coupler. Start from the bottom of the thread and draw the nozzle out from the component in a rotating motion as the epoxy is being injected.



5. Screw in the second ReidBar™ into the steel coupler, and tighten the bar using a wrench to ensure that the ReidBar™ is hard against the stop. Wipe excess filler with cloth/fabric/carton as applicable.

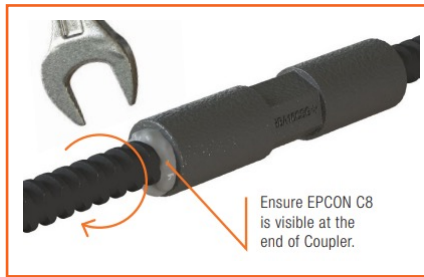

Step 5: Install

1. Lift the ReidBrace™ assembly into location.
2. Fix the RBRACE-END fitting onto the steel cleat using the pin supplied in the box set. Clip through hole in pin.
3. Place necessary means to prop the ReidBrace™

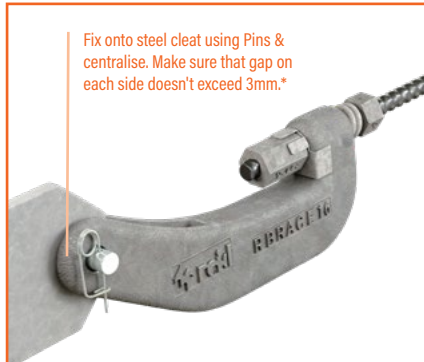

assembly so that the sag of the brace is not excessive. A sag of 1 in 100 is recommended as a maximum deflection (refer to HERA: Seismic Design of Steel Structures).

4. Fix the RBRACE fitting onto the steel cleat using the pin supplied in the box set. Fix clip through hole in pin.
5. Adjust the positions of the nuts so that the 1 in 100 maximum deflection criteria is met.
6. Tighten the Nut to fully compress the tension spring. Fold the tab washers onto the ReidBar™ Nut.

Step 6: Check

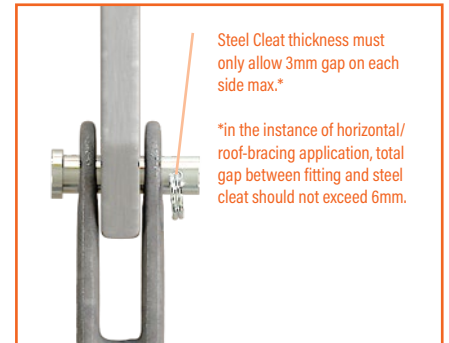

1. ReidBar™ is tightly fastened into the RBRACE-END fitting.
2. The deflection of the brace shall not exceed 1 in 100 of the brace length.

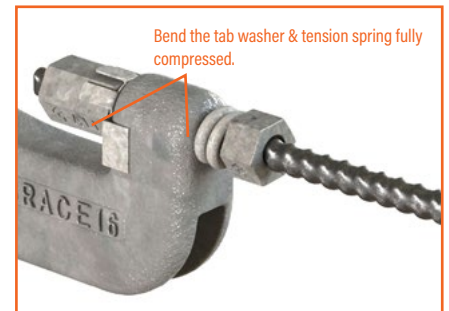

3. Tension spring is fully compressed.
4. Tab washer is folded onto the ReidBar™ Nut.
5. Supplied Pins and Clips are securely fixed to steel.
6. Steel cleat thickness must only allow 3mm gap each side of the ReidBrace™ fitting (or total maximum of 6mm in the case of horizontal/roof-bracing).
7. When coupler is used, ensure that installation & checks as per Step 4 has been carried out.

*Cyclic testing of ReidBrace™ has been carried out simulating horizontal/roof-bracing application. Therefore in the instance of horizontal/roof-bracing application, it is acceptable for the ReidBrace™ Fitting to sit flush against the steel fixture, as long as the total gap doesn't exceed 6mm.

OrbiPlate™ and ReidBrace™

Orams Marine Facility, Auckland, New Zealand

The Project

Project: Orams Marine
 Product: 20mm OrbiPlate™
 Main Contractor: MacRennie Construction
 Structural Engineer: Strata Group Consulting Engineers Ltd
 Steel fabricator: Culham Engineering
 Precast Fabricator: ConcretEtec NZ
 Crane company: Hi Lift

OrbiPlate™ and ReidBrace™ added strength and stability to this prestigious commercial construction project, saving time and money for the builders

For every glamorous activity, there is some hard work behind the scenes – something that makes everything work seamlessly and look easy. This is the case with the new Orams Marine Facility in Auckland.

This huge new marine workshop is being constructed to provide increased maintenance facilities for Auckland’s ferries, fishing vessels and commercial vessels – and the occasional superyacht. It’s a large project, even involving a 110-tonne travelator to move the boats around. It’s due to be handed over on the first week of March 2023.

Why OrbiPlate™ was chosen

Main contractor of the project, **MacRennie Construction**, chose 20mm OrbiPlate™ connectors to connect the steel to the precast panels.

Working with steel fabricator, **Culham Engineering**, and precast fabricator **ConcretEtec NZ**, the OrbiPlate™ connectors were essential to the efficiency of the build.

“We piled first, then we added footings, structural steel, then precast,” explains site manager Tony Watson of MacRennie Construction. “And our services are going on now.”

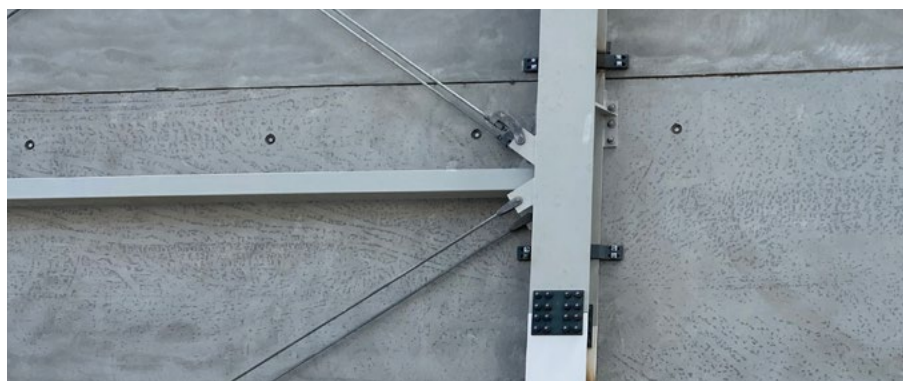

OrbiPlate™ and ReidBrace™

Orams Marine Facility, Auckland, New Zealand

MacRennie Construction discussed the precast panel installation process with Luke Price, the design engineer from **Strata Group Consulting Engineers Ltd**, because they wanted the maximum tolerance they could get at the connection point of the structural steel and precast panels.

Price recommended OrbiPlate™ connectors, which are made of high tensile steel. The OrbiPlate™ system delivers 360 degrees connection tolerances of up to 20mm in structural connections. Quick and easy to install, it delivers fine locational accuracy when positioning steel members.

The OrbiPlate™ system streamlined the install process, reducing crane time and potential delays caused by misaligned connection points having to be remediated onsite while large panels were hanging on a crane.

This was the first time that MacRennie used the OrbiPlate™ system and after installing over #1000 units of them on this project, Watson said they were happy with the product and felt it was a good system.

"It was really effective," he says. "Once the precasts were made, it was pretty straightforward."

ReidBrace™ in action

MacRennie also used Ramset's ReidBrace™ on the project, which is one of their favourite and most-used Ramset™ products.

ReidBrace™ is an off-the-shelf system that provides design engineers and constructors with an economic solution for tension bracing of structures, tie-back applications and temporary works bracing.

"We use this product on 99% of our jobs and don't have any issues with it," says Watson.

Boost for Health and Safety

Because the team was working at heights throughout the build, having a faster and smoother install not only reduced costs, but it also reduced exposure to health and safety issues.

The site has more than 30 people working at most times of the day, so safety is a big challenge.

"It's all up high," says Watson. "It's all on boom machines - there are 10 boom machines on site. Working at heights is the biggest challenge for us, as well as the fact that everyone is in a small, confined area."

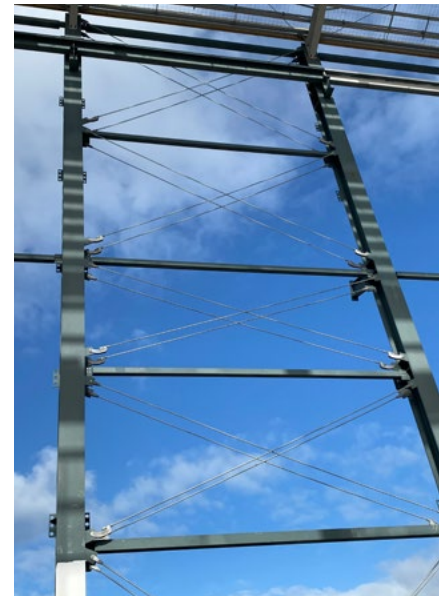

About OrbiPlate™

Ramset's patented OrbiPlate™ system delivers orbital connection tolerances of up to 20mm in structural connections. OrbiPlate™ is quick and easy to install, delivering fine locational accuracy when positioning steel members.

About ReidBrace™

ReidBrace™ is an off the shelf, out of the box system that provides design engineers and constructors with an economic solution for tension bracing of structures, tie-back applications, retrofits and temporary works bracing.

ReidBrace™ utilises ReidBar™, a user friendly continuously threaded 500E grade reinforcing bar as the tension member. ReidBrace is a unique system that is as easy as screwing on a thread to install, minimising fabrication time.

For more information,



Watch this video



Reidbrace™ Web page



OrbiPlate™ Web page

Design Tools

Ramset™ provides assistance for Engineers to choose a suitable anchoring solution which meets a project specific set of design inputs such as:

- Design tools for considering complex anchor layouts & calculating performance in grouped anchor configurations.
- Tailored outcomes to suit project specific anchoring and performance criteria.
- The latest design technology and performance calculation tools are available in hard copy or electronic format.

Specifiers Resource Book



This concise and systematically presented book contains the information most useful to Specifiers, Engineers and Architects when selecting the concrete anchoring solution that best suits their project. Selection of a concrete anchoring product is made on the basis of the basic type of fixing (bolt, stud or internally threaded), macro environment, (e.g. coastal or inland), micro environment (particular chemicals) and of course the capacity that best meets the design load case.



Scan for more information

Ramset™ iExpert™



- iExpert™ is our online anchoring design tool, which allows Engineers and design professional to work out the best product solutions for an application in line with AUS/NZ Standards.
- Featuring a simple 6 step design process, iExpert™ then provides a design report document once all the parameters have been assigned.
- Applications
- Cracked and uncracked concrete
- Seismic
- Fire



Scan for more information

Important Disclaimer: Any engineering information or advice ("Information") provided by Ramset™ in this document is issued in accordance with a prescribed standard, published performance data or design software. It is the responsibility of the user to obtain its own independent engineering (or other) advice to assess the suitability of the Information for its own requirements. To the extent permitted by law, Ramset™ will not be liable to the recipient or any third party for any direct or indirect loss or liability arising out of, or in connection with, the Information.

Customer Service

Ramset™ New Zealand
Sales, Orders and Enquiries
Tel: 0800 726 738
Email: info@ramset.co.nz
Web: www.ramset.co.nz

Website:
www.ramset.co.nz



Ramset™ Trade Centres

Tauranga	Unit 1, 15 Portside Drive, Tauranga
Auckland - Penrose	35 Station Rd, Penrose, Auckland
Auckland - Glenfield	Gate 2, 23-29 Poland Rd, Glenfield, Auckland
Hamilton	15 Somerset Street, Hamilton
Wellington	257 Thorndon Quay, Wellington
Christchurch	120 Montreal St, Christchurch



Ramset™ 1 Ramset Drive, Chirside Park 3116

Information in this document is correct at the time of printing. Readers should contact Ramset™ or consult Ramset™ detailed technical information to ensure product is suitable for intended use prior to purchase. ITW Australia Pty Ltd ABN 63 004 235 063 trading as Ramset™
© Copyright 2026.™ Trademarks of Cetram Pty. Ltd. Used under license by Ramset™

CBI555 PDL

