



**Technical and Test Institute
for Construction Prague**

Prosecká 811/76a
190 00 Prague
Czech Republic
eota@tzus.cz



Member of



www.eota.eu

European Technical Assessment

**ETA 16/0283
of 11/04/2016**

Technical Assessment Body issuing the ETA: Technical and Test Institute
for Construction Prague

Trade name of the construction product

ChemSet™ 800 Xtrem™
ChemSet™ 801 Xtrem™
ChemSet™ 802 Xtrem™
steel bonded anchor

**Product family to which the construction
product belongs**

Product area code: 33
Bonded injection type anchor for use in
cracked and non-cracked concrete

Manufacturer

RamsetReid
1 Ramset Drive
Chirside Park
Vic 3116
Australia

Manufacturing plant

ITW Australia Pty Ltd

**This European Technical Assessment
contains**

23 pages including 19 Annexes which form
an integral part of this assessment.

**This European Technical Assessment is
issued in accordance with regulation
(EU) No 305/2011, on the basis of**

ETAG 001-Part 1 and Part 5, edition 2013,
used as European Assessment Document
(EAD)

Translations of this European Technical Assessment in other languages shall fully correspond to the original issued document and should be identified as such.

Communication of this European Technical Assessment, including transmission by electronic means, shall be in full (excepted the confidential Annex(es) referred to above). However, partial reproduction may be made, with the written consent of the issuing Technical Assessment Body - Technical and Test Institute for Construction Prague. Any partial reproduction has to be identified as such.

1. Technical description of the product

The ChemSet™ 801 Xtrem™, ChemSet™ 800 Xtrem™ (faster curing time) and ChemSet™ 802 Xtrem™ (extended processing time) with steel elements is bonded anchor (injection type).

Steel elements can be galvanized or stainless steel threaded rod or rebar.

Steel element is placed into a drilled hole filled with injection mortar. The steel element is anchored via the bond between metal part, injection mortar and concrete. The anchor is intended to be used with embedment depth from 8 diameters to 20 diameters.

The illustration and the description of the product are given in Annex A.

2. Specification of the intended use in accordance with the applicable EAD

The performances given in Section 3 are only valid if the anchor is used in compliance with the specifications and conditions given in Annex B.

The provisions made in this European Technical Assessment are based on an assumed working life of the anchor of 50 years. The indications given on the working life cannot be interpreted as a guarantee given by the producer, but are to be regarded only as a means for choosing the products in relation to the expected economically reasonable working life of the works.

3. Performance of the product and references to the methods used for its assessment

3.1 Mechanical resistance and stability (BWR 1)

Essential characteristic	Performance
Characteristic resistance for tension loads - threaded rod	See Annex C 1
Characteristic resistance for tension loads - rebar	See Annex C 2
Characteristic resistance for shear loads - threaded rod	See Annex C 3
Characteristic resistance for shear loads - rebar	See Annex C 4
Characteristic resistance for tension loads - threaded rod	See Annex C 5
Characteristic resistance for tension loads - rebar	See Annex C 6
Characteristic resistance for shear loads - threaded rod	See Annex C 7
Characteristic resistance for shear loads - rebar	See Annex C 8
Displacement for threaded rod	See Annex C 9
Displacement for rebar	See Annex C 10
Characteristic resistance for tension and shear loads for seismic design - threaded rod	See Annex C 11

3.2 Safety in case of fire (BWR 2)

Essential characteristic	Performance
Reaction to fire	Anchorage satisfy requirements for Class A1
Resistance to fire	No performance assessed

3.3 Hygiene, health and environment (BWR 3)

Regarding dangerous substances contained in this European Technical Assessment, there may be requirements applicable to the products falling within its scope (e.g. transposed European legislation and national laws, regulations and administrative provisions). In order to meet the provisions of the Regulation (EU) No 305/2011, these requirements need also to be complied with, when and where they apply.

3.4 Safety in use (BWR 4)

For basic requirement safety in use the same criteria are valid as for Basic Requirement Mechanical resistance and stability.

3.5 Sustainable use of natural resources (BWR 7)

For the sustainable use of natural resources no performance was determined for this product.

3.6 General aspects relating to fitness for use

Durability and serviceability are only ensured if the specifications of intended use according to Annex B 1 are kept.

4. Assessment and verification of constancy of performance (AVCP) system applied with reference to its legal base

According to the Decision 96/582/EC of the European Commission¹ the system of assessment verification of constancy of performance (see Annex V to Regulation (EU) No 305/2011) given in the following table apply.

Product	Intended use	Level or class	System
Metal anchors for use in concrete	For fixing and/or supporting to concrete, structural elements (which contributes to the stability of the works) or heavy units	-	1

5. Technical details necessary for the implementation of the AVCP system, as provided in the applicable EAD

5.1 Tasks of the manufacturer

The manufacturer shall exercise permanent internal control of production. All the elements, requirements and provisions adopted by the manufacturer shall be documented in a systematic manner in the form of written policies and procedures, including records of results performed. This production control system shall insure that the product is in conformity with this European Technical Assessment.

The manufacturer may only use raw materials stated in the technical documentation of this European Technical Assessment.

The factory production control shall be in accordance with the control plan which is a part of the technical documentation of this European Technical Assessment. The control plan is laid down in the context of the factory production control system operated by the manufacturer and deposited at Technical and Test Institute for Construction Prague.² The results of factory production control shall be recorded and evaluated in accordance with the provisions of the control plan.

The manufacturer shall, on the basis of a contract, involve a body which is notified for the tasks referred to in section 4 in the field of anchors in order to undertake the actions laid down in section 5.2. For this purpose, the control plan referred to in this section and section 5.2 shall be handed over by the manufacturer to the notified body involved.

The manufacturer shall make a declaration of performance, stating that the construction product is in conformity with the provisions of this European Technical Assessment.

¹ Official Journal of the European Communities L 254 of 08.10.1996

² The control plan is a confidential part of the documentation of the European Technical Assessment, but not published together with the ETA and only handed over to the approved body involved in the procedure of AVCP.

5.2 Tasks of the notified bodies

The notified body shall retain the essential points of its actions referred to above and state the results obtained and conclusions drawn in a written report.

The notified certification body involved by the manufacturer shall issue a certificate of constancy of performance of the product stating the conformity with the provisions of this European Technical Assessment.

In cases where the provisions of the European Technical Assessment and its control plan are no longer fulfilled the notified body shall withdraw the certificate of constancy of performance and inform Technical and Test Institute for Construction Prague without delay.

Issued in Prague on 11.04.2016

By

Ing. Mária Schaan

Head of the Technical Assessment Body

Threaded rod

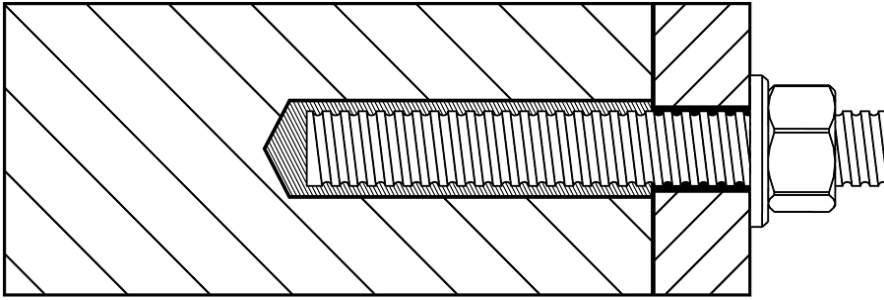

Reinforcing bar

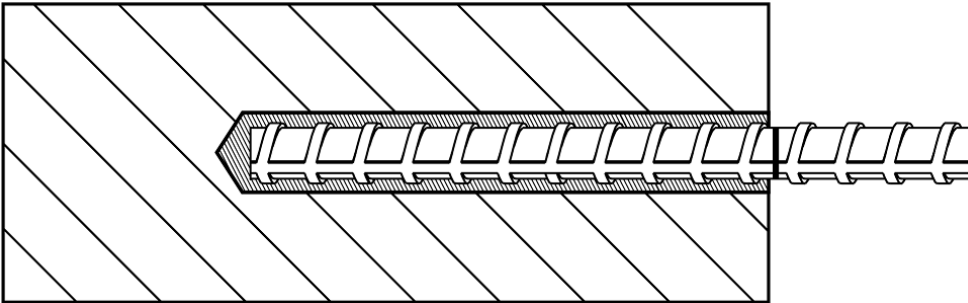

ChemSet™ 800 Xtrem™, ChemSet™ 801 Xtrem™, ChemSet™ 802 Xtrem™

Product description
Installed conditions

Annex A 1

Coaxial cartridge (Coax)

ChemSet™ 800, 801, 802 Xtrem™ 150 ml
380 ml
400 ml
410 ml

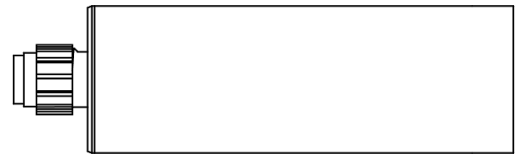

Coaxial cartridge with incorporated tap (Coax WT)

ChemSet™ 800, 801, 802 Xtrem™ 380 ml

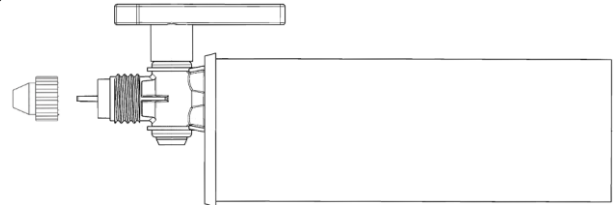

ChemSet™ 800, 801, 802 Xtrem™ 750 ml

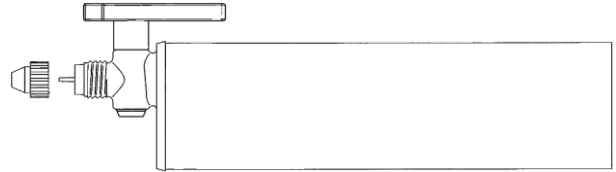

Side by side cartridge (SBS)

ChemSet™ 800, 801, 802 Xtrem™ 345 ml
350 ml

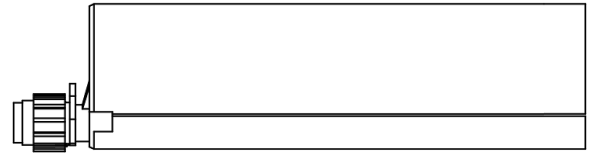

Two part foil in a single piston component cartridge (FCC)

ChemSet™ 800, 801, 802 Xtrem™ 300 ml
550 ml
850 ml

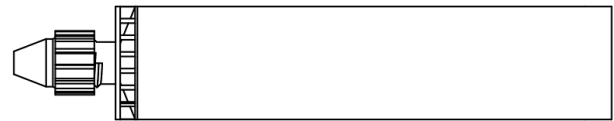

Marking of the mortar cartridges

Identifying mark of the producer, Trade name, Charge code number, Storage life, Curing and processing time

Mixing nozzle

RSM

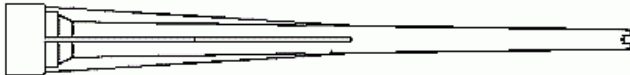

SQM

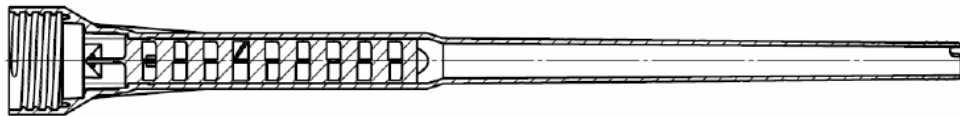

ChemSet™ 800 Xtrem™, ChemSet™ 801 Xtrem™, ChemSet™ 802 Xtrem™

Product description
Injection system

Annex A 2

Threaded rod M8, M10, M12, M16, M20, M24, M27, M30

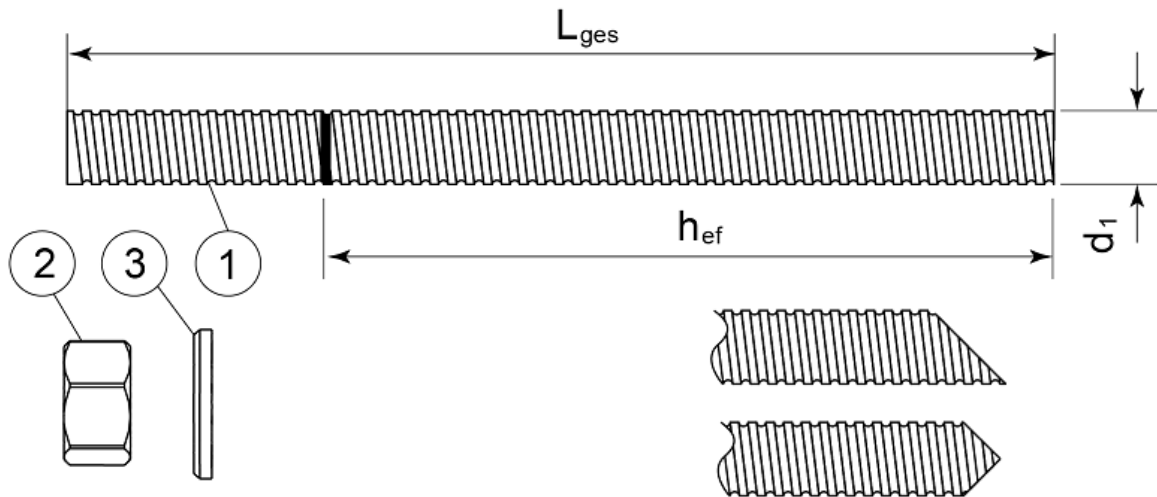

Standard commercial threaded rod with marked embedment depth

Part	Designation	Material
Steel, zinc plated $\geq 5 \mu\text{m}$ acc. to EN ISO 4042 or Steel, Hot-dip galvanized $\geq 40 \mu\text{m}$ acc. to EN ISO 1461 and EN ISO 10684 or Steel, zinc diffusion coating $\geq 15 \mu\text{m}$ acc. to EN 13811		
1	Anchor rod	Steel, EN 10087 or EN 10263 Property class 4.6, 5.8, 8.8, 10.9* EN ISO 898-1
2	Hexagon nut EN ISO 4032	According to threaded rod, EN 20898-2
3	Washer EN ISO 887, EN ISO 7089, EN ISO 7093 or EN ISO 7094	According to threaded rod
Stainless steel		
1	Anchor rod	Material: A2-70, A4-70, A4-80, EN ISO 3506
2	Hexagon nut EN ISO 4032	According to threaded rod
3	Washer EN ISO 887, EN ISO 7089, EN ISO 7093 or EN ISO 7094	According to threaded rod
High corrosion resistant steel		
1	Anchor rod	Material: 1.4529, 1.4565, EN 10088-1
2	Hexagon nut EN ISO 4032	According to threaded rod
3	Washer EN ISO 887, EN ISO 7089, EN ISO 7093 or EN ISO 7094	According to threaded rod

*Galvanized rod of high strength are sensitive to hydrogen induced brittle failure

ChemSet™ 800 Xtrem™, ChemSet™ 801 Xtrem™, ChemSet™ 802 Xtrem™

Product description
Threaded rod and materials

Annex A 3

Rebar Ø8, Ø10, Ø12, Ø16, Ø20, Ø25, Ø32



Standard commercial reinforcing bar with marked embedment depth

Product form		Bars and de-coiled rods	
Class		B	C
Characteristic yield strength f_{yk} or $f_{0,2k}$ (MPa)		400 to 600	
Minimum value of $k = (f_t/f_y)_k$		$\geq 1,08$	$\geq 1,15$ < 1,35
Characteristic strain at maximum force ϵ_{uk} (%)		$\geq 5,0$	$\geq 7,5$
Bendability		Bend/Rebend test	
Maximum deviation from nominal mass (individual bar) (%)	Nominal bar size (mm) ≤ 8	$\pm 6,0$	
	> 8	$\pm 4,5$	
Bond: Minimum relative rib area, $f_{R,min}$	Nominal bar size (mm) 8 to 12	0,040	
	> 12	0,056	

ChemSet™ 800 Xtrem™, ChemSet™ 801 Xtrem™, ChemSet™ 802 Xtrem™

Product description
Rebars and materials

Annex A 4

Specifications of intended use

Anchorage subject to:

- Static and quasi-static load.
- Seismic performance category C1: threaded rod size M10, M12, M16, M20, M24

Base materials

- Non-cracked concrete.
- Cracked and non-cracked concrete for threaded rod size M10, M12, M16, M20, M24
- Reinforced or unreinforced normal weight concrete of strength class C20/25 at minimum and C50/60 at maximum according EN 206-1:2000-12.

Temperature range:

- -40°C to +80°C (max. short. term temperature +80°C and max. long term temperature +50°C)

Use conditions (Environmental conditions)

- Structures subject to dry internal conditions (zinc coated steel, stainless steel, high corrosion resistance steel).
- Structures subject to external atmospheric exposure including industrial and marine environment, if no particular aggressive conditions exist (stainless steel, high corrosion resistance steel).
- Structures subject to permanently damp internal condition, if no particular aggressive conditions exist (stainless steel, high corrosion resistance steel).
- Structures subject to permanently damp internal condition, with particular aggressive conditions exist (high corrosion resistance steel).

Note: Particular aggressive conditions are e.g. permanent, alternating immersion in seawater or the splash zone of seawater, chloride atmosphere of indoor swimming pools or atmosphere with extreme chemical pollution (e.g. in desulphurization plants or road tunnels where de-icing materials are used).

Use categories:

- Category 2 – installation in dry or wet concrete or in flooded hole.

Design:

- The anchorages are designed in accordance with the EOTA Technical Report TR 029 "Design of bonded anchors" under the responsibility of an engineer experienced in anchorages and concrete work.
- Verifiable calculation notes and drawings are prepared taking account of the loads to be anchored. The position of the anchor is indicated on the design drawings.
- Anchorages under seismic actions (cracked concrete) have to be designed in accordance with EOTA Technical Report TR 045 "Design of Metal Anchors under Seismic Action".

Installation:

- Dry or wet concrete or flooded hole.
- Hole drilling by hammer drill mode.
- Anchor installation carried out by appropriately qualified personnel and under the supervision of the person responsible for technical matters of the site.

ChemSet™ 800 Xtrem™, ChemSet™ 801 Xtrem™, ChemSet™ 802 Xtrem™

Intended use
Specifications

Annex B 1

Applicator gun

A



B



C



D



E



F



F1



G



H



Applicator gun	A	B	C	D	E	F (F1)	G	H
Cartridge	Coax 380 Coax 400 Coax 410	Coax 380 Coax 400 Coax WT 380	SBS 345 SBS 350	FCC 300 FCC 550	FCC 300	Coax WT 380 Coax WT 750	Coax WT 380 Coax WT 750	FCC 850

Cleaning brush

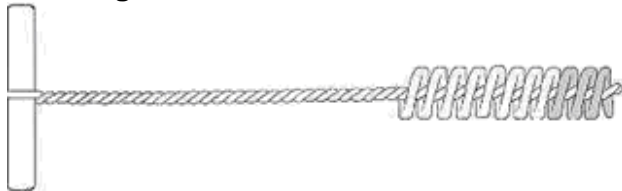

ChemSet™ 800 Xtrem™, ChemSet™ 801 Xtrem™, ChemSet™ 802 Xtrem™

Intended use
Applicator guns
Cleaning brush

Annex B 2

Installation instructions



1. Drill hole to specified diameter and depth with Ramset™ DynaDrill™

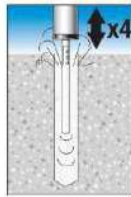

2. Blow dust and debris from hole using 2 swift pumps of Hole Blower



3. Brush 2 times for the full depth of the hole

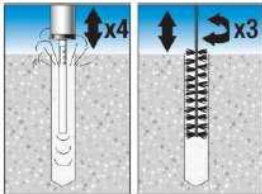

4. Repeat Steps 2. and 3.

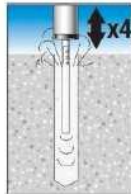

5. Blow dust and debris from hole using 2 swift pumps of Hole Blower

6. If water is present, brush sides of hole



7. Follow any special opening instructions on the cartridge label and attach mixing nozzle



8. Load cartridge into applicator



9. Dispense initial 1 or 2 trigger pulls to waste to ensure correct mixing

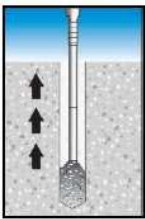

10. Insert end of nozzle to bottom of hole and squeeze trigger to dispense adhesive, withdrawing nozzle as hole fills

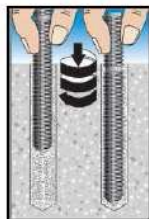

11. Insert fixing with a twisting motion to release trapped air

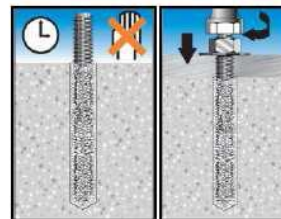

12. Do not disturb fixing until curing time has elapsed. Attach fixture and tighten nut to recommended torque

ChemSet™ 800 Xtrem™, ChemSet™ 801 Xtrem™, ChemSet™ 802 Xtrem™

Intended use
Installation procedure

Annex B 3

Table B1: Installation parameters of threaded rod

Size			M8	M10	M12	M16	M20	M24	M27	M30
Nominal drill hole diameter	Ød ₀	[mm]	10	12	14	18	22	26	30	35
Diameter of cleaning brush	d _b	[mm]	14	14	20	20	29	29	40	40
Torque moment	T _{inst}	[Nm]	10	20	40	80	150	200	240	275
h _{ef,min} = 8d										
Depth of drill hole	h ₀	[mm]	64	80	96	128	160	192	216	240
Minimum edge distance	c _{min}	[mm]	35	40	50	65	80	96	110	120
Minimum spacing	s _{min}	[mm]	35	40	50	65	80	96	110	120
Minimum thickness of member	h _{min}	[mm]	h _{ef} + 30 mm ≥ 100 mm				h _{ef} + 2d ₀			
h _{ef,max} = 20d										
Depth of drill hole	h ₀	[mm]	160	200	240	320	400	480	540	600
Minimum edge distance	c _{min}	[mm]	80	100	120	160	200	240	270	300
Minimum spacing	s _{min}	[mm]	80	100	120	160	200	240	270	300
Minimum thickness of member	h _{min}	[mm]	h _{ef} + 30 mm ≥ 100 mm				h _{ef} + 2d ₀			

Table B2: Installation parameters of rebar

Size			Ø8	Ø10	Ø12	Ø16	Ø20	Ø25	Ø32	
Nominal drill hole diameter	Ød ₀	[mm]	12	14	16	20	25	32	40	
Diameter of cleaning brush	d _b	[mm]	14	14	19	22	29	40	42	
h _{ef,min} = 8d										
Depth of drill hole	h ₀	[mm]	64	80	96	128	160	200	256	
Minimum edge distance	c _{min}	[mm]	35	40	50	65	80	100	130	
Minimum spacing	s _{min}	[mm]	35	40	50	65	80	100	130	
Minimum thickness of member	h _{min}	[mm]	h _{ef} + 30 mm ≥ 100 mm				h _{ef} + 2d ₀			
h _{ef,max} = 20d										
Depth of drill hole	h ₀	[mm]	160	200	240	320	400	500	640	
Minimum edge distance	c _{min}	[mm]	80	100	120	160	200	250	320	
Minimum spacing	s _{min}	[mm]	80	100	120	160	200	250	320	
Minimum thickness of member	h _{min}	[mm]	h _{ef} + 30 mm ≥ 100 mm				h _{ef} + 2d ₀			

Table B3: Cleaning

All diameters
- 2 x blowing
- 2 x brushing
- 2 x blowing
- 2 x brushing
- 2 x blowing

Table B4: Minimum curing time

ChemSet™ 801 Xtrem™		
Application temperature	Processing time	Load time
+5 to +10°C	10 mins	145 mins
+10 to +15°C	8 mins	85 mins
+15 to +20°C	6 mins	75 mins
+20 to +25°C	5 mins	50 mins
+25 to +30°C	4 mins	40 mins

Processing time refers to the highest temperature in the range.
Load time refers to the lowest temperature in the range.
Cartridge must be conditioned to a minimum +5°C.

ChemSet™ 800 Xtrem™		
Application temperature	Processing time	Load time
-10 to -5°C	50 mins	12 hours
-5 to 0°C	15 mins	100 mins
0 to +5°C	10 mins	75 mins
+5 to +20°C	5 mins	50 mins
+20°C	100 second	20 mins

Processing time refers to the highest temperature in the range.
Load time refers to the lowest temperature in the range.
Cartridge must be conditioned to a minimum 0°C.

ChemSet™ 802 Xtrem™		
Application temperature	Processing time	Load time
+15 to +20°C	15 mins	5 hours
+20 to +25°C	10 mins	145 mins
+25 to +30°C	7.5 mins	85 mins
+30 to +35°C	5 mins	50 mins
+35 to +40°C	3.5 mins	40 mins

Processing time refers to the highest temperature in the range.
Load time refers to the lowest temperature in the range.
Cartridge must be conditioned to a minimum +15°C.

ChemSet™ 800 Xtrem™, ChemSet™ 801 Xtrem™, ChemSet™ 802 Xtrem™

Intended use
Installation parameters
Curing time

Annex B 4

Table C1: Design method TR 029

Characteristic values of resistance to tension load of threaded rod

Steel failure – Characteristic resistance											
Size			M8	M10	M12	M16	M20	M24	M27	M30	
Steel grade 4.6	$N_{Rk,s}$	[kN]	15	23	34	63	98	141	184	224	
Partial safety factor	$\gamma_{Ms}^{1)}$	[-]	2,00								
Steel grade 5.8	$N_{Rk,s}$	[kN]	18	29	42	79	123	177	230	281	
Partial safety factor	$\gamma_{Ms}^{1)}$	[-]	1,50								
Steel grade 8.8	$N_{Rk,s}$	[kN]	29	46	67	126	196	282	367	449	
Partial safety factor	$\gamma_{Ms}^{1)}$	[-]	1,50								
Steel grade 10.9	$N_{Rk,s}$	[kN]	37	58	84	157	245	353	459	561	
Partial safety factor	$\gamma_{Ms}^{1)}$	[-]	1,33								
Stainless steel grade A2-70, A4-70	$N_{Rk,s}$	[kN]	26	41	59	110	172	247	321	393	
Partial safety factor	$\gamma_{Ms}^{1)}$	[-]	1,87								
Stainless steel grade A4-80	$N_{Rk,s}$	[kN]	29	46	67	126	196	282	367	449	
Partial safety factor	$\gamma_{Ms}^{1)}$	[-]	1,60								
Stainless steel grade 1.4529	$N_{Rk,s}$	[kN]	26	41	59	110	172	247	321	393	
Partial safety factor	$\gamma_{Ms}^{1)}$	[-]	1,50								
Stainless steel grade 1.4565	$N_{Rk,s}$	[kN]	26	41	59	110	172	247	321	393	
Partial safety factor	$\gamma_{Ms}^{1)}$	[-]	1,87								

Combined pullout and concrete cone failure in non-cracked concrete C20/25											
Size			M8	M10	M12	M16	M20	M24	M27	M30	
Characteristic bond resistance in non-cracked concrete											
Dry and wet concrete	τ_{Rk}	[N/mm ²]	11	10	9,5	9	8,5	8	6,5	5,5	
Partial safety factor	$\gamma_{Mc}^{1)}$	[-]	1,8 ²⁾						2,1 ³⁾		
Flooded hole	τ_{Rk}	[N/mm ²]	9	8	7,5	7	7	6	/		
Partial safety factor	$\gamma_{Mc}^{1)}$	[-]	2,1 ³⁾								
Factor for concrete C50/60	ψ_c	[-]	1								

Combined pullout and concrete cone failure in cracked concrete C20/25										
Size			M10	M12	M16	M20	M24			
Characteristic bond resistance in cracked concrete										
Dry and wet concrete	τ_{Rk}	[N/mm ²]	5	5	5	4,5	4,5			
Partial safety factor	$\gamma_{Mc}^{1)}$	[-]	1,8 ²⁾							
Flooded hole	τ_{Rk}	[N/mm ²]	5	5	5	4,5	4,5			
Partial safety factor	$\gamma_{Mc}^{1)}$	[-]	2,1 ³⁾							
Factor for cracked concrete	C30/37 C40/50 C50/60	ψ_c	[-]			1,12 1,23 1,30				

Splitting failure										
Size			M8	M10	M12	M16	M20	M24	M27	M30
Edge distance	$C_{cr,sp}$	[mm]	1,5h _{ef}							
Spacing	$S_{cr,sp}$	[mm]	3,0h _{ef}							
Partial safety factor	$\gamma_{Msp}^{1)}$	[-]	1,8							

1) In absence of national regulations

2) The partial safety factor $\gamma_2=1,2$ is included3) The partial safety factor $\gamma_2=1,4$ is included**ChemSet™ 800 Xtrem™, ChemSet™ 801 Xtrem™, ChemSet™ 802 Xtrem™****Performances**

Design according to TR 029

Characteristic resistance for tension loads - threaded rod

Annex C 1

Table C2: Design method TR 029

Characteristic values of resistance to tension load of rebar

Steel failure – Characteristic resistance									
Size			Ø8	Ø10	Ø12	Ø16	Ø20	Ø25	Ø32
Rebar BSt 500 S	$N_{Rk,s}$	[kN]	28	43	62	111	173	270	442
Partial safety factor	$\gamma_{Ms}^{1)}$	[-]	1,4						

Combined pullout and concrete cone failure in non-cracked concrete C20/25										
Size			Ø8	Ø10	Ø12	Ø16	Ø20	Ø25	Ø32	
Characteristic bond resistance in non-cracked concrete										
Dry and wet concrete			τ_{Rk}	[N/mm ²]	12	10	10	9	9	5,5
Partial safety factor	$\gamma_{Mc}^{1)}$	[-]	1,8 ²⁾							
Flooded hole			τ_{Rk}	[N/mm ²]	12	10	10	9	9	5,5
Partial safety factor	$\gamma_{Mc}^{1)}$	[-]	2,1 ³⁾							
Factor for concrete C50/60	ψ_c	[-]	1							

Splitting failure									
Size			Ø8	Ø10	Ø12	Ø16	Ø20	Ø25	Ø32
Edge distance	$c_{cr,sp}$	[mm]	1,5 h_{ef}						
Spacing	$s_{cr,sp}$	[mm]	3,0 h_{ef}						
Partial safety factor	$\gamma_{Msp}^{1)}$	[-]	1,8						

1) In absence of national regulations

2) The partial safety factor $\gamma_2=1,2$ is included3) The partial safety factor $\gamma_2=1,4$ is included

ChemSet™ 800 Xtrem™, ChemSet™ 801 Xtrem™, ChemSet™ 802 Xtrem™

Performances

Design according to TR 029

Characteristic resistance for tension loads - rebar

Annex C 2

Table C3: Design method TR 029
Characteristic values of resistance to shear load of threaded rod

Steel failure without lever arm									
Size		M8	M10	M12	M16	M20	M24	M27	M30
Steel grade 4.6	$V_{Rk,s}$ [kN]	7	12	17	31	49	71	92	112
Partial safety factor	$\gamma_{Ms}^{1)}$ [-]	1,67							
Steel grade 5.8	$V_{Rk,s}$ [kN]	9	15	21	39	61	88	115	140
Partial safety factor	$\gamma_{Ms}^{1)}$ [-]	1,25							
Steel grade 8.8	$V_{Rk,s}$ [kN]	15	23	34	63	98	141	184	224
Partial safety factor	$\gamma_{Ms}^{1)}$ [-]	1,25							
Steel grade 10.9	$V_{Rk,s}$ [kN]	18	29	42	79	123	177	230	281
Partial safety factor	$\gamma_{Ms}^{1)}$ [-]	1,5							
Stainless steel grade A2-70, A4-70	$V_{Rk,s}$ [kN]	13	20	30	55	86	124	161	196
Partial safety factor	$\gamma_{Ms}^{1)}$ [-]	1,56							
Stainless steel grade A4-80	$V_{Rk,s}$ [kN]	15	23	34	63	98	141	184	224
Partial safety factor	$\gamma_{Ms}^{1)}$ [-]	1,33							
Stainless steel grade 1.4529	$V_{Rk,s}$ [kN]	13	20	30	55	86	124	161	196
Partial safety factor	$\gamma_{Ms}^{1)}$ [-]	1,25							
Stainless steel grade 1.4565	$V_{Rk,s}$ [kN]	13	20	30	55	86	124	161	196
Partial safety factor	$\gamma_{Ms}^{1)}$ [-]	1,56							

Steel failure with lever arm									
Size		M8	M10	M12	M16	M20	M24	M27	M30
Steel grade 4.6	$M^o_{Rk,s}$ [N.m]	15	30	52	133	260	449	666	900
Partial safety factor	$\gamma_{Ms}^{1)}$ [-]	1,67							
Steel grade 5.8	$M^o_{Rk,s}$ [N.m]	19	37	66	166	325	561	832	1125
Partial safety factor	$\gamma_{Ms}^{1)}$ [-]	1,25							
Steel grade 8.8	$M^o_{Rk,s}$ [N.m]	30	60	105	266	519	898	1332	1799
Partial safety factor	$\gamma_{Ms}^{1)}$ [-]	1,25							
Steel grade 10.9	$M^o_{Rk,s}$ [N.m]	37	75	131	333	649	1123	1664	2249
Partial safety factor	$\gamma_{Ms}^{1)}$ [-]	1,50							
Stainless steel grade A2-70, A4-70	$M^o_{Rk,s}$ [N.m]	26	52	92	233	454	786	1165	1574
Partial safety factor	$\gamma_{Ms}^{1)}$ [-]	1,56							
Stainless steel grade A4-80	$M^o_{Rk,s}$ [N.m]	30	60	105	266	519	898	1332	1799
Partial safety factor	$\gamma_{Ms}^{1)}$ [-]	1,33							
Stainless steel grade 1.4529	$M^o_{Rk,s}$ [N.m]	26	52	92	233	454	786	1165	1574
Partial safety factor	$\gamma_{Ms}^{1)}$ [-]	1,25							
Stainless steel grade 1.4565	$M^o_{Rk,s}$ [N.m]	26	52	92	233	454	786	1165	1574
Partial safety factor	$\gamma_{Ms}^{1)}$ [-]	1,56							
Concrete pryout failure									
Factor <i>k</i> from TR 029		2							
Design of bonded anchors, Part 5.2.3.3		2							
Partial safety factor	$\gamma_{Mp}^{1)}$ [-]	1,5							

Concrete edge failure									
Size		M8	M10	M12	M16	M20	M24	M27	M30
See section 5.2.3.4 of Technical Report TR 029 for the Design of Bonded Anchors									
Partial safety factor	$\gamma_{Mc}^{1)}$ [-]	1,5							

¹⁾ In absence of national regulations

ChemSet™ 800 Xtrem™, ChemSet™ 801 Xtrem™, ChemSet™ 802 Xtrem™

Performances

Design according to TR 029
Characteristic resistance for shear loads - threaded rod

Annex C 3

Table C4: Design method TR 029
Characteristic values of resistance to shear load of rebar

Steel failure without lever arm									
Size			Ø8	Ø10	Ø12	Ø16	Ø20	Ø25	Ø32
Rebar BSt 500 S	$V_{Rk,s}$	[kN]	14	22	31	55	86	135	221
Partial safety factor	$\gamma_{Ms}^{1)}$	[-]	1,5						

Steel failure with lever arm									
Size			Ø8	Ø10	Ø12	Ø16	Ø20	Ø25	Ø32
Rebar BSt 500 S	$M^o_{Rk,s}$	[N.m]	33	65	112	265	518	1013	2122
Partial safety factor	$\gamma_{Ms}^{1)}$	[-]	1,5						

Concrete pryout failure									
Factor <i>k</i> from TR 029			2						
Design of bonded anchors, Part 5.2.3.3			2						
Partial safety factor	$\gamma_{Mp}^{1)}$	[-]	1,5						

Concrete edge failure									
Size			Ø8	Ø10	Ø12	Ø16	Ø20	Ø25	Ø32
See section 5.2.3.4 of Technical Report TR 029 for the Design of Bonded Anchors									
Partial safety factor	$\gamma_{Mc}^{1)}$	[-]	1,5						

¹⁾ In absence of national regulations

ChemSet™ 800 Xtrem™, ChemSet™ 801 Xtrem™, ChemSet™ 802 Xtrem™

Performances

Design according to TR 029
Characteristic resistance for shear loads - rebar

Annex C 4

Table C5: Design method CEN/TS 1992-4

Characteristic values of resistance to tension load of threaded rod

Steel failure – Characteristic resistance											
Size			M8	M10	M12	M16	M20	M24	M27	M30	
Steel grade 4.6	$N_{Rk,s}$	[kN]	15	23	34	63	98	141	184	224	
Partial safety factor	$\gamma_{Ms}^{1)}$	[-]	2,00								
Steel grade 5.8	$N_{Rk,s}$	[kN]	18	29	42	79	123	177	230	281	
Partial safety factor	$\gamma_{Ms}^{1)}$	[-]	1,50								
Steel grade 8.8	$N_{Rk,s}$	[kN]	29	46	67	126	196	282	367	449	
Partial safety factor	$\gamma_{Ms}^{1)}$	[-]	1,50								
Steel grade 10.9	$N_{Rk,s}$	[kN]	37	58	84	157	245	353	459	561	
Partial safety factor	$\gamma_{Ms}^{1)}$	[-]	1,33								
Stainless steel grade A2-70, A4-70	$N_{Rk,s}$	[kN]	26	41	59	110	172	247	321	393	
Partial safety factor	$\gamma_{Ms}^{1)}$	[-]	1,87								
Stainless steel grade A4-80	$N_{Rk,s}$	[kN]	29	46	67	126	196	282	367	449	
Partial safety factor	$\gamma_{Ms}^{1)}$	[-]	1,60								
Stainless steel grade 1.4529	$N_{Rk,s}$	[kN]	26	41	59	110	172	247	321	393	
Partial safety factor	$\gamma_{Ms}^{1)}$	[-]	1,50								
Stainless steel grade 1.4565	$N_{Rk,s}$	[kN]	26	41	59	110	172	247	321	393	
Partial safety factor	$\gamma_{Ms}^{1)}$	[-]	1,87								
Combined pullout and concrete cone failure in non-cracked concrete C20/25											
Size			M8	M10	M12	M16	M20	M24	M27	M30	
Characteristic bond resistance in non-cracked concrete											
Dry and wet concrete	τ_{Rk}	[N/mm ²]	11	10	9,5	9	8,5	8	6,5	5,5	
Partial safety factor	$\gamma_{Mc}^{1)}$	[-]	1,8 ²⁾							2,1 ³⁾	
Flooded hole	τ_{Rk}	[N/mm ²]	9	8	7,5	7	7	6			
Partial safety factor	$\gamma_{Mc}^{1)}$	[-]	2,1 ³⁾								
Factor for concrete C50/60	ψ_c	[-]	1								
Factor according to CEN/TS 1992-4-5 Section 6.2.2	k_8		10,1								
Combined pullout and concrete cone failure in cracked concrete C20/25											
Size			M10	M12	M16	M20	M24				
Characteristic bond resistance in cracked concrete											
Dry and wet concrete	τ_{Rk}	[N/mm ²]	5	5	5	4,5	4,5				
Partial safety factor	$\gamma_{Mc}^{1)}$	[-]	1,8 ²⁾								
Flooded hole	τ_{Rk}	[N/mm ²]	5	5	5	4,5	4,5				
Partial safety factor	$\gamma_{Mc}^{1)}$	[-]	2,1 ³⁾								
Factor for cracked concrete	ψ_c	[-]					1,12				
							1,23				
							1,30				
Factor according to CEN/TS 1992-4-5 Section 6.2.2	k_8		7,2								
Concrete cone failure											
Size			M8	M10	M12	M16	M20	M24	M27	M30	
Factor according to CEN/TS 1992-4-5 Section 6.2.3	$\frac{k_{ucr}}{k_{cr}}$						10,1				
							7,2				
Edge distance	$c_{cr,N}$	[mm]					1,5h _{ef}				
Spacing	$s_{cr,N}$	[mm]					3,0h _{ef}				
Splitting failure											
Edge distance	$c_{cr,sp}$	[mm]					1,5h _{ef}				
Spacing	$s_{cr,sp}$	[mm]					3,0h _{ef}				
Partial safety factor	$\gamma_{Msp}^{1)}$	[-]	1,8								

¹⁾ In absence of national regulations

²⁾ The partial safety factor $\gamma_2=1,2$ is included

³⁾ The partial safety factor $\gamma_2=1,4$ is included

ChemSet™ 800 Xtrem™, ChemSet™ 801 Xtrem™, ChemSet™ 802 Xtrem™

Performances

Design according to CEN/TS 1992-4

Characteristic resistance for tension loads - threaded rod

Annex C 5

Table C6: Design method CEN/TS 1992-4
Characteristic values of resistance to tension load of rebar

Steel failure – Characteristic resistance											
Size			Ø8	Ø10	Ø12	Ø16	Ø20	Ø25	Ø32		
Rebar BSt 500 S	$N_{Rk,s}$	[kN]	28	43	62	111	173	270	442		
Partial safety factor	$\gamma_{Ms}^{1)}$	[-]	1,4								
Combined pullout and concrete cone failure in non-cracked concrete C20/25											
Size			Ø8	Ø10	Ø12	Ø16	Ø20	Ø25	Ø32		
Characteristic bond resistance in non-cracked concrete											
Dry and wet concrete			τ_{RK}	[N/mm ²]	12	10	10	9	9	9	5,5
Partial safety factor	$\gamma_{Mc}^{1)}$	[-]	1,8 ²⁾								
Flooded hole			τ_{RK}	[N/mm ²]	12	10	10	9	9	9	5,5
Partial safety factor	$\gamma_{Mc}^{1)}$	[-]	2,1 ³⁾								
Factor for concrete C50/60	ψ_c	[-]	1								
Factor according to CEN/TS 1992-4-5 Section 6.2.2	k_8		10,1								
Concrete cone failure											
Size			Ø8	Ø10	Ø12	Ø16	Ø20	Ø25	Ø32		
Factor according to CEN/TS 1992-4-5 Section 6.2.3			k_{ucr}	10,1							
Edge distance	$c_{cr,N}$	[mm]	1,5 h_{ef}								
Spacing	$s_{cr,N}$	[mm]	3,0 h_{ef}								
Splitting failure											
Edge distance	$c_{cr,sp}$	[mm]	1,5 h_{ef}								
Spacing	$s_{cr,sp}$	[mm]	3,0 h_{ef}								
Partial safety factor	$\gamma_{Msp}^{1)}$	[-]	1,8								

¹⁾ In absence of national regulations

²⁾ The partial safety factor $\gamma_2=1,2$ is included

³⁾ The partial safety factor $\gamma_2=1,4$ is included

ChemSet™ 800 Xtrem™, ChemSet™ 801 Xtrem™, ChemSet™ 802 Xtrem™

Performances

Design according to CEN/TS 1992-4
Characteristic resistance for tension loads - rebar

Annex C 6

Table C7: Design method CEN/TS 1992-4
Characteristic values of resistance to shear load of threaded rod

Steel failure without lever arm									
Size		M8	M10	M12	M16	M20	M24	M27	M30
Steel grade 4.6	$V_{Rk,s}$ [kN]	7	12	17	31	49	71	92	112
Partial safety factor	$\gamma_{Ms}^{1)}$ [-]	1,67							
Steel grade 5.8	$V_{Rk,s}$ [kN]	9	15	21	39	61	88	115	140
Partial safety factor	$\gamma_{Ms}^{1)}$ [-]	1,25							
Steel grade 8.8	$V_{Rk,s}$ [kN]	15	23	34	63	98	141	184	224
Partial safety factor	$\gamma_{Ms}^{1)}$ [-]	1,25							
Steel grade 10.9	$V_{Rk,s}$ [kN]	18	29	42	79	123	177	230	281
Partial safety factor	$\gamma_{Ms}^{1)}$ [-]	1,5							
Stainless steel grade A2-70, A4-70	$V_{Rk,s}$ [kN]	13	20	30	55	86	124	161	196
Partial safety factor	$\gamma_{Ms}^{1)}$ [-]	1,56							
Stainless steel grade A4-80	$V_{Rk,s}$ [kN]	15	23	34	63	98	141	184	224
Partial safety factor	$\gamma_{Ms}^{1)}$ [-]	1,33							
Stainless steel grade 1.4529	$V_{Rk,s}$ [kN]	13	20	30	55	86	124	161	196
Partial safety factor	$\gamma_{Ms}^{1)}$ [-]	1,25							
Stainless steel grade 1.4565	$V_{Rk,s}$ [kN]	13	20	30	55	86	124	161	196
Partial safety factor	$\gamma_{Ms}^{1)}$ [-]	1,56							
Ductility factor according to CEN/TS 1992-4-5 Section 6.3.2.1	k_2	0,8							
Steel failure with lever arm									
Size		M8	M10	M12	M16	M20	M24	M27	M30
Steel grade 4.6	$M^o_{Rk,s}$ [N.m]	15	30	52	133	260	449	666	900
Partial safety factor	$\gamma_{Ms}^{1)}$ [-]	1,67							
Steel grade 5.8	$M^o_{Rk,s}$ [N.m]	19	37	66	166	325	561	832	1125
Partial safety factor	$\gamma_{Ms}^{1)}$ [-]	1,25							
Steel grade 8.8	$M^o_{Rk,s}$ [N.m]	30	60	105	266	519	898	1332	1799
Partial safety factor	$\gamma_{Ms}^{1)}$ [-]	1,25							
Steel grade 10.9	$M^o_{Rk,s}$ [N.m]	37	75	131	333	649	1123	1664	2249
Partial safety factor	$\gamma_{Ms}^{1)}$ [-]	1,50							
Stainless steel grade A2-70, A4-70	$M^o_{Rk,s}$ [N.m]	26	52	92	233	454	786	1165	1574
Partial safety factor	$\gamma_{Ms}^{1)}$ [-]	1,56							
Stainless steel grade A4-80	$M^o_{Rk,s}$ [N.m]	30	60	105	266	519	898	1332	1799
Partial safety factor	$\gamma_{Ms}^{1)}$ [-]	1,33							
Stainless steel grade 1.4529	$M^o_{Rk,s}$ [N.m]	26	52	92	233	454	786	1165	1574
Partial safety factor	$\gamma_{Ms}^{1)}$ [-]	1,25							
Stainless steel grade 1.4565	$M^o_{Rk,s}$ [N.m]	26	52	92	233	454	786	1165	1574
Partial safety factor	$\gamma_{Ms}^{1)}$ [-]	1,56							
Concrete pryout failure									
Factor according to CEN/TS 1992-4-5 Section 6.3.3	k_3	2,0							
Partial safety factor	$\gamma_{Mp}^{1)}$ [-]	1,5							
Concrete edge failure									
Size		M8	M10	M12	M16	M20	M24	M27	M30
See section 6.3.4 of CEN/TS 1992-4-5									
Effective length of anchor	l_f [mm]	$l_f = \min(h_{ef}; 8 d_{nom})$							
Outside diameter of anchor	d_{nom} [mm]	8	10	12	16	20	24	27	30
Partial safety factor	$\gamma_{Mc}^{1)}$ [-]	1,5							

¹⁾ In absence of national regulations

ChemSet™ 800 Xtrem™, ChemSet™ 801 Xtrem™, ChemSet™ 802 Xtrem™

Performances

Design according to CEN/TS 1992-4
Characteristic resistance for shear loads - threaded rod

Annex C 7

Table C8: Design method CEN/TS 1992-4
Characteristic values of resistance to shear load of rebar

Steel failure without lever arm										
Size			Ø8	Ø10	Ø12	Ø16	Ø20	Ø25	Ø32	
Rebar BSt 500 S	$V_{Rk,s}$	[kN]	14	22	31	55	86	135	221	
Partial safety factor	$\gamma_{Ms}^{1)}$	[-]	1,5							
Ductility factor according to CEN/TS 1992-4-5 Section 6.3.2.1	k_2		0,8							
Steel failure with lever arm										
Size			Ø8	Ø10	Ø12	Ø16	Ø20	Ø25	Ø32	
Rebar BSt 500 S	$M^o_{Rk,s}$	[N.m]	33	65	112	265	518	1013	2122	
Partial safety factor	$\gamma_{Ms}^{1)}$	[-]	1,5							
Concrete pryout failure										
Factor according to CEN/TS 1992-4-5 Section 6.3.3	k_3		2,0							
Partial safety factor	$\gamma_{Mp}^{1)}$	[-]	1,5							
Concrete edge failure										
Size			Ø8	Ø10	Ø12	Ø16	Ø20	Ø25	Ø32	
See section 6.3.4 of CEN/TS 1992-4-5										
Effective length of anchor	l_f	[mm]	$l_f = \min(h_{ef}; 8 d_{nom})$							
Outside diameter of anchor	d_{nom}	[mm]	8	10	12	16	20	24	30	
Partial safety factor	$\gamma_{Mc}^{1)}$	[-]	1,5							

¹⁾ In absence of national regulations

ChemSet™ 800 Xtrem™, ChemSet™ 801 Xtrem™, ChemSet™ 802 Xtrem™

Performances

Design according to CEN/TS 1992-4
Characteristic resistance for shear loads - rebar

Annex C 8

Table C9: Displacement of threaded rod under tension and shear load

Anchor size			M8	M10	M12	M16	M20	M24	M27	M30
Non-cracked concrete										
Tension load	F	[kN]	6,3	7,9	11,9	15,9	23,8	29,8	37,7	45,6
Displacement	δ_{N0}	[mm]	0,3	0,3	0,3	0,3	0,4	0,5	0,5	0,5
	$\delta_{N\infty}$	[mm]	0,5	0,5	0,5	0,5	0,5	0,5	0,5	0,5
Shear load	F	[kN]	3,1	5,0	7,2	13,5	21,0	30,3	39,4	48,0
Displacement	δ_{V0}	[mm]	1,5	1,5	1,5	1,5	2,0	2,5	2,5	2,5
	$\delta_{V\infty}$	[mm]	2,3	2,3	2,3	2,3	3,0	3,8	3,8	3,8
Cracked concrete										
Tension load	F	[kN]		5,1	7,4	13,1	20,5	24,6		
Displacement	δ_{N0}	[mm]		0,4	0,7	0,7	0,7	0,6		

ChemSet™ 800 Xtrem™, ChemSet™ 801 Xtrem™, ChemSet™ 802 Xtrem™

Performances
Displacement for threaded rod

Annex C 9

Table C10: Displacement of rebar under tension and shear load

Rebar size			Ø8	Ø10	Ø12	Ø16	Ø20	Ø25	Ø32
Non-cracked concrete									
Tension load	F	[kN]	7,9	9,9	13,9	23,8	29,8	55,6	55,6
Displacement	δ_{N0}	[mm]	0,3	0,3	0,3	0,4	0,4	0,5	0,5
	$\delta_{N\infty}$	[mm]	0,5	0,5	0,5	0,5	0,5	0,5	0,5
Shear load	F	[kN]	5,9	9,3	13,3	23,7	37,0	57,9	94,8
Displacement	δ_{V0}	[mm]	0,3	0,4	0,4	0,4	0,4	0,5	0,9
	$\delta_{V\infty}$	[mm]	0,5	0,6	0,6	0,6	0,6	0,8	1,4

ChemSet™ 800 Xtrem™, ChemSet™ 801 Xtrem™, ChemSet™ 802 Xtrem™

Performances
Displacement for rebar

Annex C 10

Table C11: Characteristic values of resistance under seismic action category C1 for threaded rods

Size			M10	M12	M16	M20	M24
Tension load							
Steel failure							
Characteristic resistance grade 4.6	$N_{Rk,s,seis}$	[kN]	23	34	63	98	141
Partial safety factor	$\gamma_{Ms}^{1)}$	[-]	2,00				
Characteristic resistance grade 5.8	$N_{Rk,s,seis}$	[kN]	29	42	79	123	177
Partial safety factor	$\gamma_{Ms}^{1)}$	[-]	1,50				
Characteristic resistance grade 8.8	$N_{Rk,s,seis}$	[kN]	46	67	126	196	282
Partial safety factor	$\gamma_{Ms}^{1)}$	[-]	1,50				
Characteristic resistance grade 10.9	$N_{Rk,s,seis}$	[kN]	58	84	157	245	353
Partial safety factor	$\gamma_{Ms}^{1)}$	[-]	1,33				
Characteristic resistance A2-70, A4-70	$N_{Rk,s,seis}$	[kN]	41	59	110	172	247
Partial safety factor	$\gamma_{Ms}^{1)}$	[-]	1,87				
Characteristic resistance A4-80	$N_{Rk,s,seis}$	[kN]	46	67	126	196	282
Partial safety factor	$\gamma_{Ms}^{1)}$	[-]	1,60				
Characteristic resistance 1.4529	$N_{Rk,s,seis}$	[kN]	41	59	110	172	247
Partial safety factor	$\gamma_{Ms}^{1)}$	[-]	1,50				
Characteristic resistance 1.4565	$N_{Rk,s,seis}$	[kN]	41	59	110	172	247
Partial safety factor	$\gamma_{Ms}^{1)}$	[-]	1,87				
Combined pull-out and concrete cone failure							
Dry and wet concrete	$T_{Rk,seis,C1}$	[N/mm ²]	3,9	3,9	3,9	3,9	3,9
Partial safety factor	$\gamma_{Mc}^{1)}$	[-]	1,8 ²⁾				
Flooded hole	$T_{Rk,seis,C1}$	[N/mm ²]	3,9	3,9	3,9	3,9	3,9
Partial safety factor	$\gamma_{Mc}^{1)}$	[-]	2,1 ³⁾				
Shear load							
Steel failure without lever arm							
Characteristic resistance grade 4.6	$V_{Rk,s,seis}$	[kN]	7	10	23	30	40
Partial safety factor	$\gamma_{Ms}^{1)}$	[-]	1,67				
Characteristic resistance grade 5.8	$V_{Rk,s,seis}$	[kN]	9	13	28	38	51
Partial safety factor	$\gamma_{Ms}^{1)}$	[-]	1,25				
Characteristic resistance grade 8.8	$V_{Rk,s,seis}$	[kN]	14	21	45	61	81
Partial safety factor	$\gamma_{Ms}^{1)}$	[-]	1,25				
Characteristic resistance grade 10.9	$V_{Rk,s,seis}$	[kN]	18	26	56	76	101
Partial safety factor	$\gamma_{Ms}^{1)}$	[-]	1,50				
Characteristic resistance A2-70, A4-70	$V_{Rk,s,seis}$	[kN]	12	18	39	53	71
Partial safety factor	$\gamma_{Ms}^{1)}$	[-]	1,56				
Characteristic resistance A4-80	$V_{Rk,s,seis}$	[kN]	14	21	45	61	81
Partial safety factor	$\gamma_{Ms}^{1)}$	[-]	1,33				
Characteristic resistance 1.4529	$V_{Rk,s,seis}$	[kN]	12	18	39	53	71
Partial safety factor	$\gamma_{Ms}^{1)}$	[-]	1,25				
Characteristic resistance 1.4565	$V_{Rk,s,seis}$	[kN]	12	18	39	53	71
Partial safety factor	$\gamma_{Ms}^{1)}$	[-]	1,56				

¹⁾ In absence of national regulations

²⁾ The partial safety factor $\gamma_2=1,2$ is included

³⁾ The partial safety factor $\gamma_2=1,4$ is included

Note: Rebars are not qualified for seismic design

ChemSet™ 800 Xtrem™, ChemSet™ 801 Xtrem™, ChemSet™ 802 Xtrem™

Performances
Reduction factors for seismic design

Annex C 11